

# YAMAHA CDX-9

*Natural Sound Compact Disc Player*

*Lecteur de disque audionumérique de la série "Natural Sound"*

*Natural Sound CD-Spieler*

*Natural Sound Compact Disc-spelare*

*Lettole di compact disc a suono naturale*

*Tocadiscos de Discos Compactos de Sonido Natural*

*Natural Sound CD-speler*



**OWNER'S MANUAL  
MODE D'EMPLOI  
BEDIENUNGSANLEITUNG  
BRUKSANVISNING  
MANUALE DI ISTRUZIONI  
MANUAL DE INSTRUCCIONES  
GEBRUIKSAANWIJZING**

### CAUTION

As the laser beam used in this compact disc player is harmful to the eyes, do not attempt to disassemble the cabinet. Refer servicing to qualified personnel only.

### ACHTUNG

Verwendung von Reglern, Einstellungen oder Eingriffe von anderer Natur als hierin angegeben kann die Aussetzung gefährlicher Strahlendosen nach sich ziehen.

### ADVARSEL

Usynlig laserstråling ved åbning. Undgå udsættelse for stråling.

### VAROITUS

Laitteen käyttäminen muulla kuin tässä käyttöohjeessa mainitulla tavalla saattaa altistaa käyttäjän turvallisuusluokan 1 ylittävälle näkymättömälle lasersäteilylle.

### WARNING

Om apparaten används på annat sätt än i denna bruksanvisning specificerats, kan användaren utsättas för osynlig laserstråling, som överskrider gränsen för laserklass 1.

### LET OP

Aangezien de laserstraal die in deze compact-disc speler gebruikt wordt gevaar kan opleveren voor de ogen, nooit proberen de behuizing van het apparaat te verwijderen. Laat onderhoud uitsluitend uitvoeren door een deskundige reparateur.

Varningsanvisning för laserstråling. Placerad i apparaten.

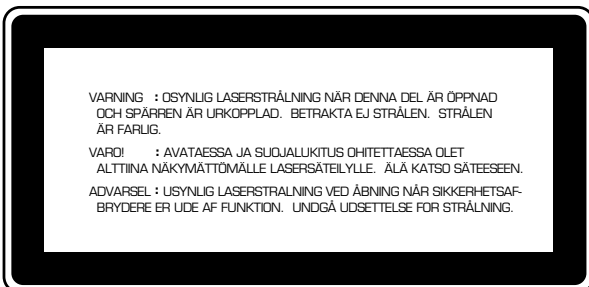

Klassmärkning för Finland

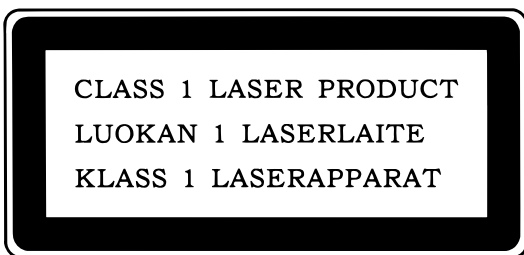

### Laser Diode Properties

- Material: GaAlAs
  - Wavelength: 780nm
  - Emission Duration: continuous
  - Laser Output: max. 44.6µW\*
- \* This output is the value measured at a distance of about 200mm from the objective lens surface on the Optical Pick-up Block.

### CAUTION

The STANDBY/ON switch does not disconnect the complete apparatus from the mains line.

### ATTENTION

L'appareil reste toujours sous tension lorsque l'interrupteur d'attente/marche est en position arrêt.

### ACHTUNG

Das Gerät kann mit dem Netzschalter (STANDBY/ON) nicht vollständig von der Stromversorgung getrennt werden.

### OBSERVERA!

STANDBY/ON-omkopplaren kopplar inte bort växelströmskällan (nätet) så länge som apparaten är ansluten till vägguttaget, även om själva apparaten har stängts av.

### ADVARSEL

Netspændingen STANDBY/ON til dette apparat er IKKE afbrudt, så længe netledningen sidder i en stikkontakt, som er tændt – også selvom der er slukket på apparatets afbryder.

### VAROITUS

Laitteen STANDBY/ON-kytkin ei kytke laitetta sähköverkosta.

### AVVERTENZA

L'apparecchio rimane sotto tensione anche quando viene spento tramite l'interruttore STANDBY/ON.

### For U.K. customers

If the socket outlets in the home are not suitable for the plug supplied with this appliance, it should be cut off and an appropriate 3 pin plug fitted. For details, refer to the instructions described below.

**Note:** The plug severed from the mains lead must be destroyed, as a plug with bared flexible cord is hazardous if engaged in a live socket outlet.

### SPECIAL INSTRUCTIONS FOR U.K. MODEL

#### IMPORTANT:

The wire in the mains lead are coloured in accordance with the following code:

Blue: NEUTRAL  
Brown: LIVE

The colours of the wires in the mains lead of this apparatus may not correspond with the coloured markings identifying the terminals in your plug. Proceed as follows: the wire which is coloured BLUE must be connected to the terminal which is marked with the letter N or coloured BLACK. The wire which is coloured BROWN must be connected to the terminal which is marked with the letter L or coloured RED. Making sure that neither core is connected to the earth terminal of the three pin plug.

### Alleen voor klanten in Nederland

Bij dit produkt zijn batterijen geleverd. Wanneer deze leeg zijn, moet u ze niet weggooien maar inleveren als KCA.

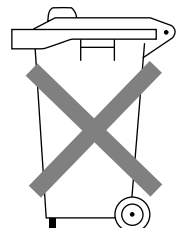

Thank you for selecting this YAMAHA compact disc player.

## FEATURES

- Random Access Programmable Play
- Random-Sequence Play
- Single Track/Entire Disc Repeat Play
- Automatic Spacing Capability
- Automatic Programming for Recording to Tape
- Automatic Peak Level Searching Capability
- CD Synchronized Recording with a Compatible YAMAHA Tape Deck
- Display Brightness Changing Capability
- Remote Control Capability
- Optical Digital Output

## CONTENTS

Caution .....	3
Connections .....	4
Identification of Components .....	5
Basic Operation .....	7
Random-sequence Play .....	11
Repeat Play .....	11
Program Play .....	12
Index Search .....	13
Track Programming for Recording to Tape .....	14
CD Synchronized Recording .....	18
Notes about the Remote Control Transmitter .....	19
Notes about Handling Compact Discs .....	19
Troubleshooting .....	20
Specifications .....	20

## CAUTION: READ THIS BEFORE OPERATING YOUR UNIT.

1. This unit is a sophisticated compact disc player. To ensure proper operation for the best possible performance, please read this manual carefully.
2. Choose the installation location of your unit carefully. Avoid placing it in direct sunlight or close to a source of heat. Also avoid locations subject to vibration and excessive dust, heat, cold or moisture. Keep it away from sources of hum such as transformers or motors.
3. Do not place another component on top of this unit, because to do so will discolor or damage the surface of the unit.
4. Do not open the cabinet of this unit, because to do so might result in damage to the unit, or injury by electric shock. If any foreign object or substance enters the unit, contact your dealer for assistance.
5. To prevent damage by lightning, disconnect the power cord from the household AC outlet during an electrical storm.
6. When disconnecting the power cord from the household AC outlet, grasp the plug; do not pull the cord.
7. Do not apply excessive force when using switches and controls.
8. When moving the unit, be sure to first disconnect the power cord from the household AC outlet, and disconnect cords connected to other equipment.
9. Do not attempt to clean the unit with chemical solvent as this might damage the finish. Use a clean, dry cloth.
10. Be sure to read the "TROUBLESHOOTING" section for advice on common operating errors before concluding that your unit is faulty.
11. Keep this manual in a safe place for future reference.
12. **Voltage selector (General model only)**  
**The voltage selector (on the rear panel of this unit) must be correctly set to the voltage used locally before making any connection to the AC power supply.**

This unit is not disconnected from the AC power source as long as it is connected to the wall outlet, even if this unit itself is turned off. (standby mode)

### WARNING

To reduce the risk of fire or electric shock, do not expose this appliance to rain or moisture.

To avoid electrical shock, do not open the cabinet. Refer servicing to qualified personnel only.

#### DANGER

Invisible laser radiation when open and interlock failed or defeated. Avoid direct exposure to beam.

#### CAUTION

Use of controls or adjustments or performance of procedures other than those specified herein may result in hazardous radiation exposure.

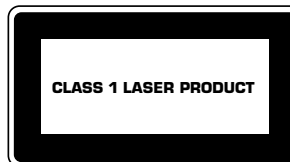

This compact disc player is classified as a CLASS 1 LASER product. The CLASS 1 LASER PRODUCT label is located on the rear exterior. (Europe and U.K. models only)

Laser component in this product is capable of emitting radiation exceeding the limit for Class 1.

#### CAUTION (FOR CANADA MODEL)

TO PREVENT ELECTRIC SHOCK, MATCH WIDE BLADE OF PLUG TO WIDE SLOT AND FULLY INSERT.

#### FOR CANADIAN CUSTOMER

THIS CLASS B DIGITAL APPARATUS MEETS ALL REQUIREMENTS OF THE CANADIAN INTERFERENCE-CAUSING EQUIPMENT REGULATIONS.

#### IMPORTANT

Please record the serial number of this unit in the space below.

Serial No.:

The serial number is located on the rear of the unit. Retain this Owner's Manual in a safe place for future reference.

# CONNECTIONS

**Never plug in this unit and other components until all connections are completed.**

- Connections should be made to the correct input terminals of the amplifier or other component.
- If the placement of this unit causes noise to other equipment, such as a tuner, separate them from each other.

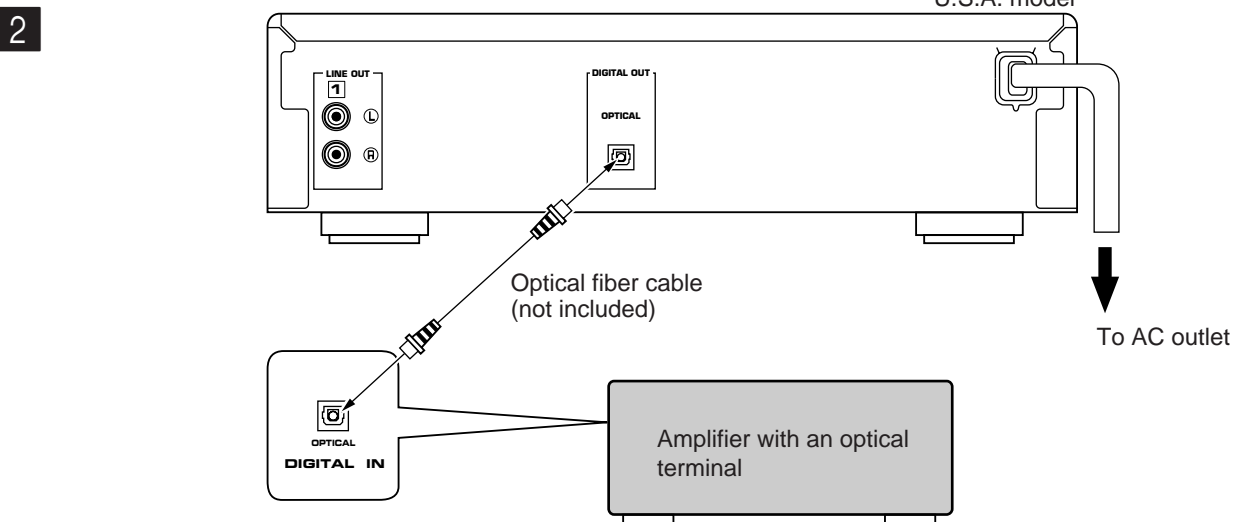
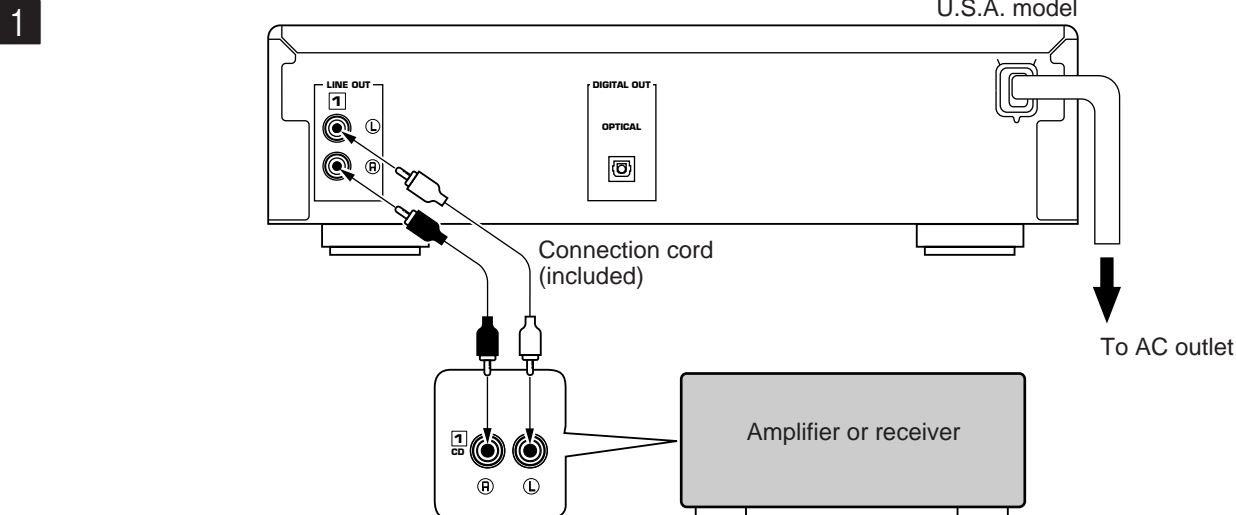

Choose one of the ways listed below to connect this unit to your amplifier.

## When the LINE OUT (analog) terminals of this unit are used ( 1 )

- Be sure that the left (“L”) and right (“R”) LINE OUT terminals are connected to the corresponding (left and right) terminals of the amplifier or other component.
- Connect the “LINE OUT” terminals to the “CD” (or “AUX”) terminals of the amplifier. If the amplifier does not have such terminals, use the “TAPE PB” terminals. For additional details concerning these connections, refer to the operation instructions for the amplifier being used.
- The LINE OUT terminals of this unit are numbered 1. When connecting this unit with a YAMAHA amplifier or receiver whose terminals on the rear panel are numbered as 1, 2, 3, etc., connect the LINE OUT terminals of this unit to the input terminals numbered 1 on the rear of the amplifier or receiver.

## When the DIGITAL OUT (OPTICAL) terminal of this unit is used ( 2 )

- Before using this terminal, remove the terminal’s cover by pulling it.
- Make the connection from this terminal to the optical input terminal of an amplifier by using a commercially available optical fiber cable.
  - \* Use an optical fiber cable that conforms to EIAJ standards. Other cables might not function correctly.
- Be sure to attach the terminal’s cover when this terminal is not being used, in order to protect the terminal from dust.
- This terminal can also be connected to the optical input terminal of a digital audio tape deck (DAT), MD recorder, etc. to record CD onto tape or MD directly.

# IDENTIFICATION OF COMPONENTS

\* ( ) indicates the page number on which the control part is best described.

## FRONT PANEL

\* The **SKIP/SEARCH** buttons on the main unit have both the functions of the **SKIP** button and the **SEARCH** button on the remote control transmitter.

\* The **PLAY/PAUSE** button on the main unit has both the functions of the **PLAY** button and the **PAUSE** button on the remote control transmitter.

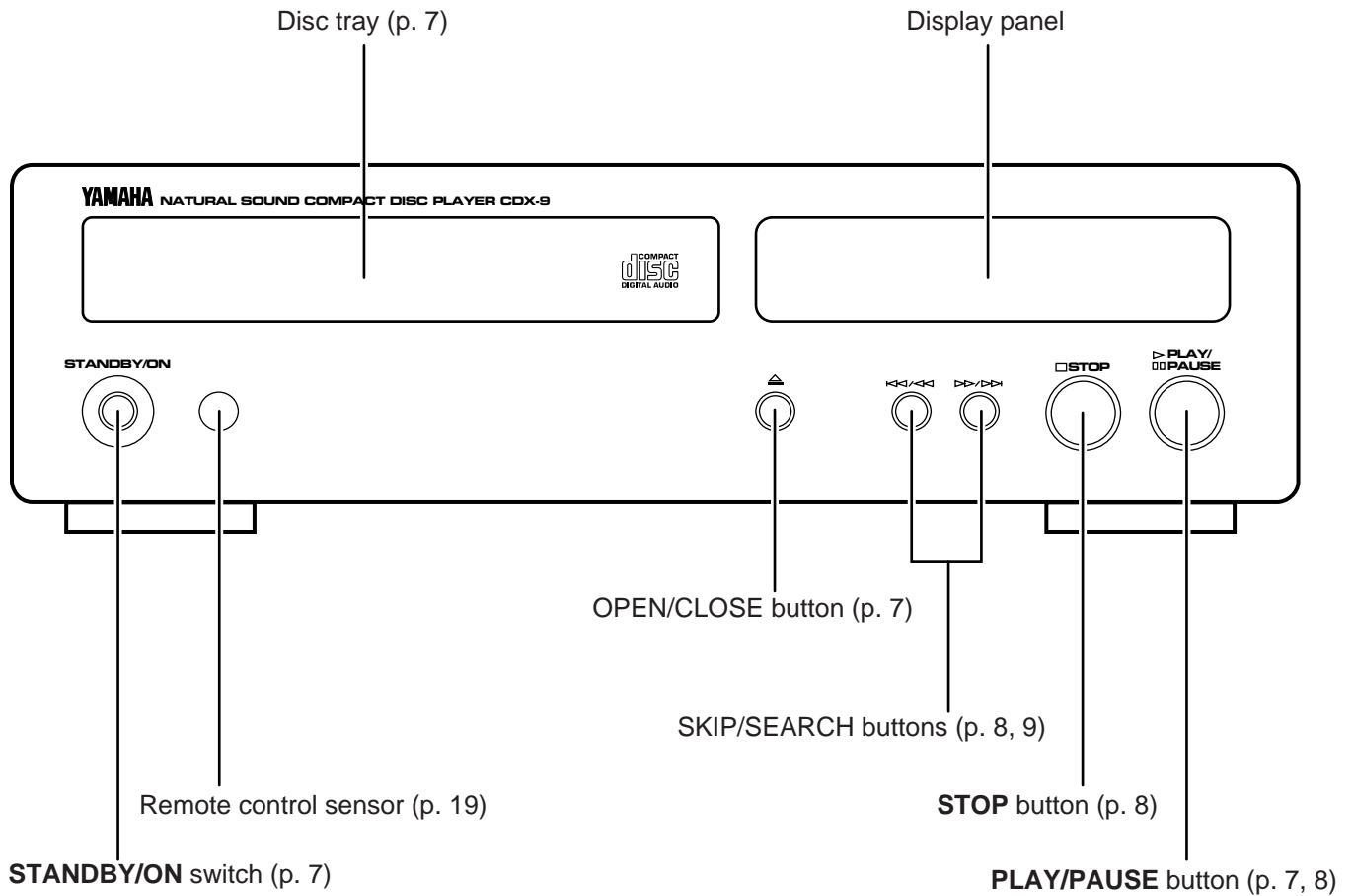

\* ( ) indicates the page number on which the control part is best described.

## REMOTE CONTROL TRANSMITTER

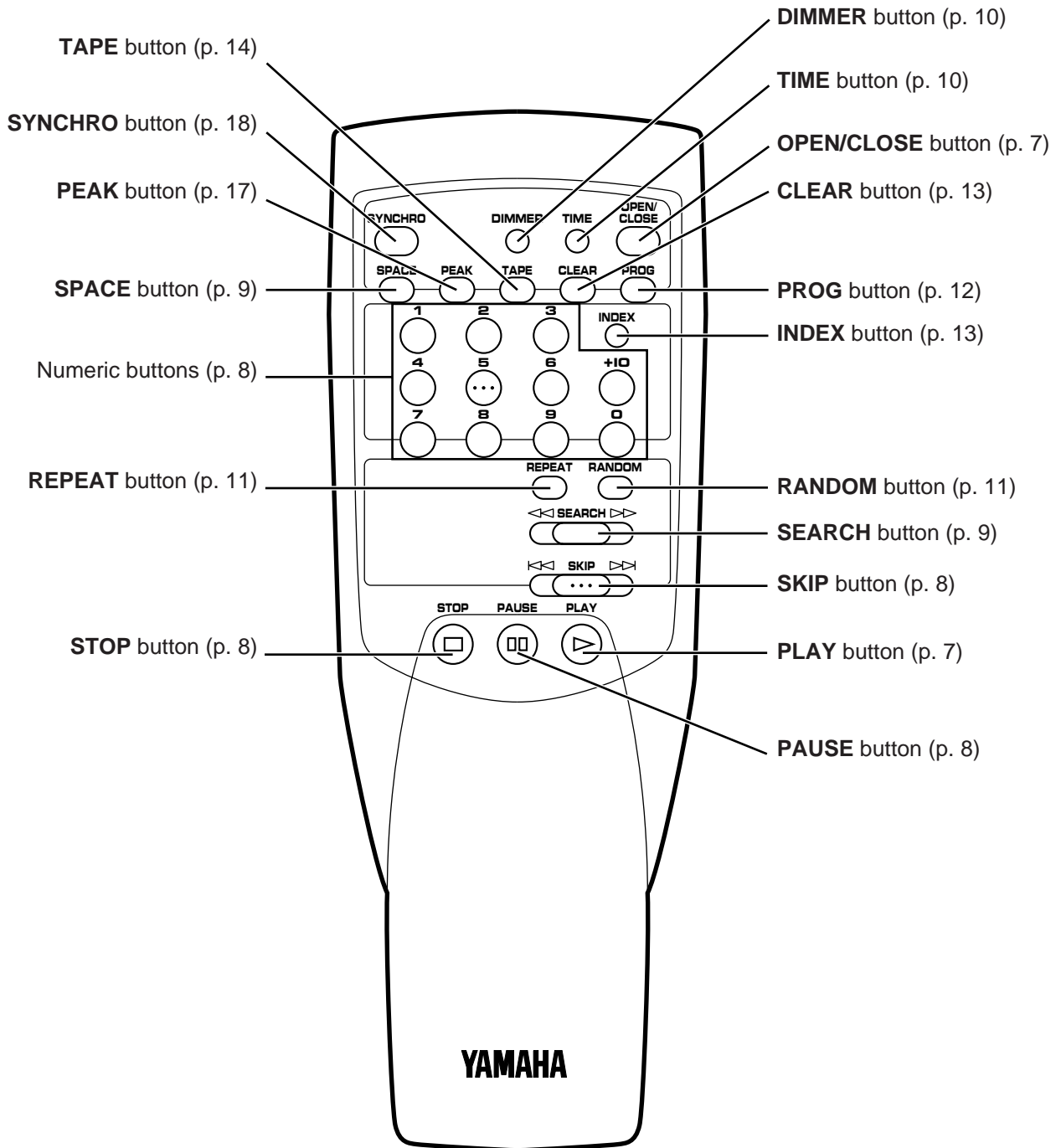

This manual describes how to operate this unit by using the remote control transmitter. To operate this unit on the front panel, use the corresponding buttons on the front panel.

# BASIC OPERATION

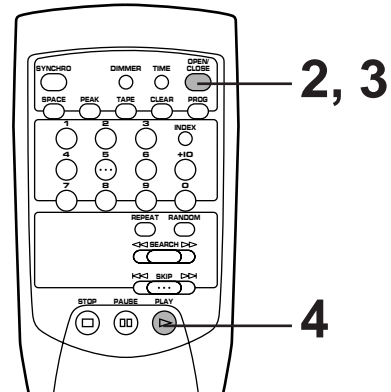
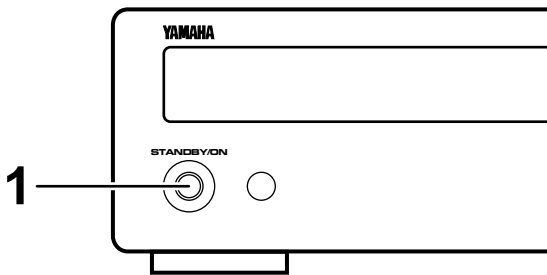

**1** Turn the power on.

**2** Load a disc.

Label side upward

Disc tray

**3** Close the disc tray.

**4**

Play will begin from the first track of the disc.

## Display information at disc play

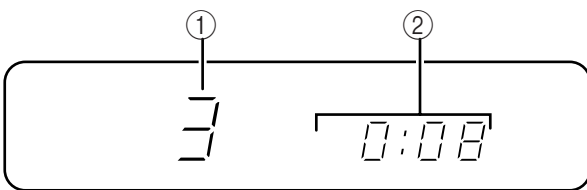

- ① Shows the track number selected or being played.
- ② Shows the time displays. (Refer to "Selecting time displays" on page 10.)

## Notes

- After closing the disc tray by pressing the **OPEN/CLOSE** button, the display shows the total number of tracks and the total recorded time of the disc for a few seconds.

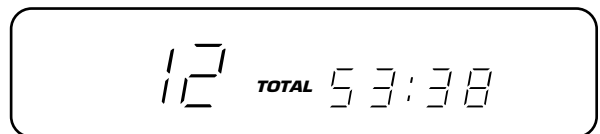

- Additionally, you can close the disc tray by pressing the **PLAY (PLAY/PAUSE)** button, a numeric button or the **RANDOM** button, or by pressing the front edge of the disc tray gently. If the tray is closed in these ways, play will begin automatically, however, the display will not show the total number of tracks and the total recorded time of the disc.

## When you finish using this unit

Press the **STANDBY/ON** switch again to turn this unit into the standby mode.

### Standby mode

In this state, this unit is not disconnected from the source as long as it is connected to the wall outlet, even if this unit itself is turned off.

## To stop play temporarily

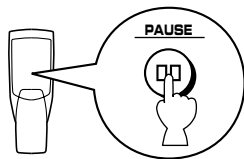

To resume play, press the **PAUSE** button again (or press the **PLAY** button).

\* The **PLAY/PAUSE** button on the front panel can also be used to stop play temporarily or to resume play.

## To stop play completely

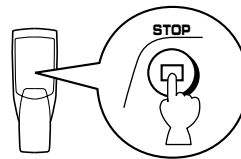

## To play a desired track on the disc

### DIRECT PLAY

Select a desired track using the numeric button.

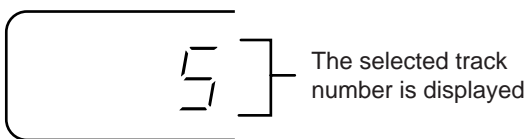
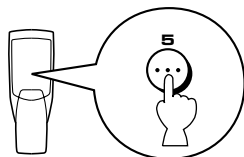

Example: To select track 25  
Press ① twice, then immediately press ② once.

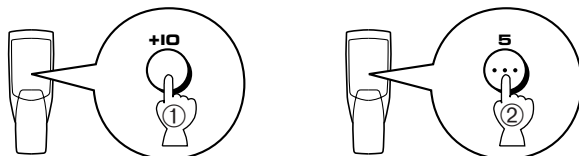

\* If a track number higher than the highest track number on the disc is selected, the last track on the disc will be played.

### SKIP PLAY

To play from the beginning of the track following the one now playing

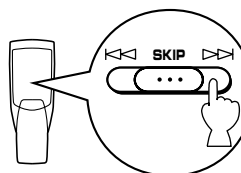

To play from the beginning of the track now playing

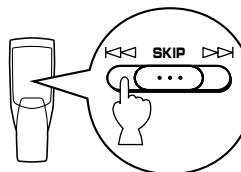

To play from the beginning of the track before the one now playing

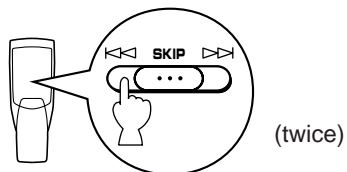

- These operations can also be performed when the unit is in the pause or stop mode.
- When using the **SKIP** button on the remote control transmitter:

If the button is pressed and held, the track number is continuously changed to higher numbers (or lower numbers).

When using the **SKIP/SEARCH** buttons on the front panel: Be careful not to press and hold a button, otherwise the selected track is played forward (or backward) rapidly.

### Caution

When the disc tray is open, **do not touch the inside gear wheel**. If you touch the gear wheel, your finger may be caught in the closing tray and injured.

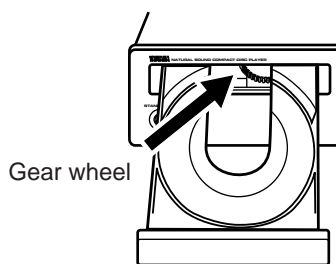



## To advance or reverse play rapidly (MANUAL SEARCH)

### To advance rapidly

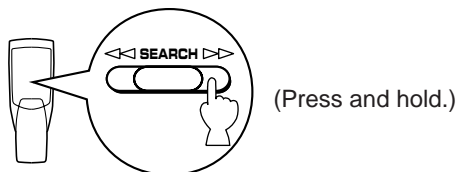

- The sound can be heard (although slightly garbled) during manual search in either direction. This is convenient for locating a precise position within a track, or for reviewing the contents quickly.
- Manual search can also be performed while disc play is paused, though no sound will be heard.
- When using the SKIP/SEARCH buttons on the front panel: Be careful not to release a button just after it is pressed, otherwise the play is skipped to the beginning of the next track or returned to the beginning of the current track.

### To reverse rapidly

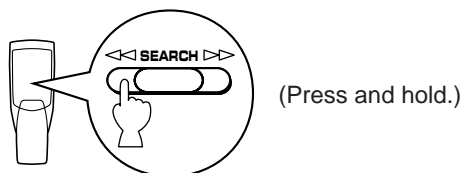

## Automatic spacing

If you record a disc onto tape with an insufficient time space between tracks, the tape deck will not be able to perform blank search operations on the tape correctly. Such a search mistake of the deck can be prevented by pressing the auto-**SPACE** button to insert spaces of about 4 seconds between the tracks before recording.

### Note

When the automatic spacing function is in effect, the display of the total time and of the total remaining time will include each of the 4 second non-recorded intervals placed between tracks.

### To cancel the automatic spacing function



## Selecting time displays

You can select any of the four time displays by pressing the **TIME** display mode-select button.

- ① Elapsed time of the track now playing



- ② Remaining time of the track now playing

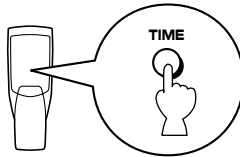
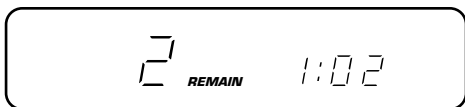

- ④ Total remaining time on the disc

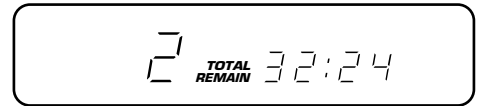

- ③ Total disc play time

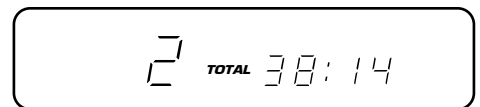

### Note

The remaining time ② will not be displayed if the track number is 25 or higher.

---

## Changing brightness of the display

If desired, you can change brightness of the display in three degrees by pressing the **DIMMER** button.

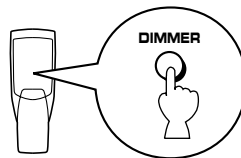

Normal illumination



Slightly dim



Dim



## RANDOM-SEQUENCE PLAY

You can have the unit play the tracks on a disc in a random sequence selected by the unit's microcomputer.

### To perform random-sequence play

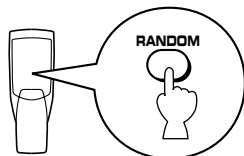

### To cancel random-sequence play

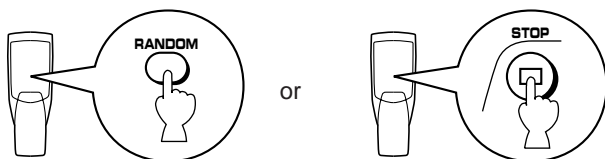

#### Notes

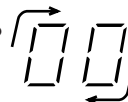
- This feature will not function during programming, or during programmed play.
- If the **SKIP** ▷ button is pressed during random-sequence play, the next randomly programmed track will be played. If the **SKIP** ◀ button is pressed, play will return to the beginning of the track now being played.
-  This indication appears while the unit is mixing up tracks.
- Total remaining time on the disc will not be displayed during random-sequence play.

## REPEAT PLAY

You can play any desired track or the entire disc repeatedly by pressing the **REPEAT** button. The repeat play mode will change whenever you press the **REPEAT** button.

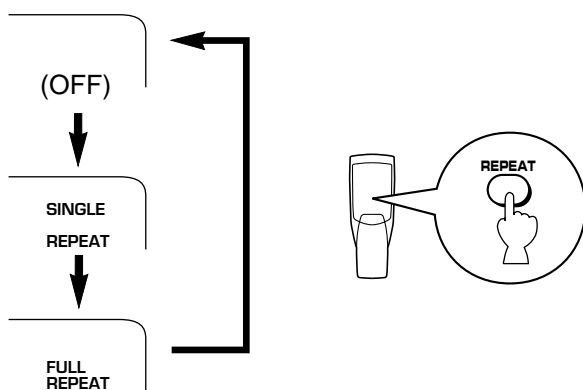

#### SINGLE REPEAT

A single track is repeatedly played.

- \* This is also available in the programmed-play mode and the random-sequence play mode.

(If the repeat play mode is switched off, the programmed-play mode or the random-sequence play mode will be resumed.)

#### FULL REPEAT

All tracks (the entire disc) are played repeatedly.

- \* In the programmed-play mode, all programmed tracks are repeatedly played.
- \* In the random-sequence play mode, all randomly sequenced tracks are repeatedly played in the same order.

# PROGRAM PLAY

You can enjoy listening to your favorite tracks in any desired order by programming tracks. As many as 25 tracks can be programmed in sequence.

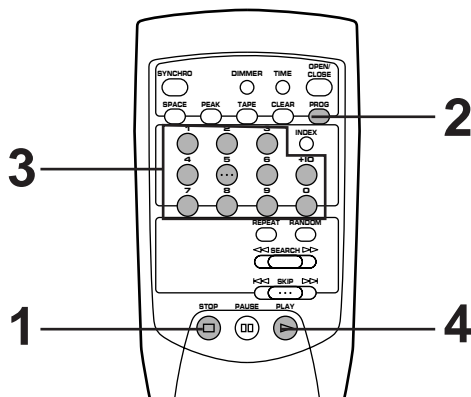

**1** Stop the unit.

**2**

Flashes.

**3** Program a desired track by pressing the corresponding numeric button.

\* Repeat this operation to program more tracks. You can select the same track again.

**4**

## Display information during programming

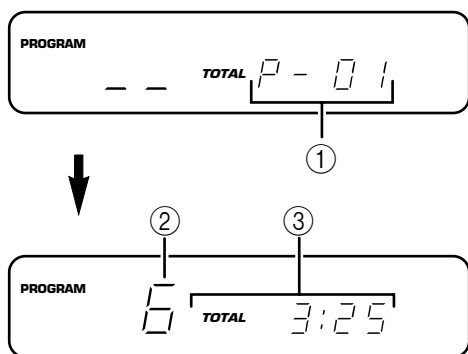

- ① Shows the program number for the track to be programmed next.
- ② Shows the selected track number.
- ③ Shows the total time of the tracks currently programmed.

\* If the total time becomes 100 minutes or more, the highest position of a figure will not be displayed.

## Notes

- In step 2, if "P-01" does not appear in the display, press the **TIME** display mode-select button.
- If, during programming, the **TIME** display mode-select button is pressed, the program number display can be changed to display the total time of the programmed tracks. To return to the previous display, press the **TIME** display mode-select button once again.
- The **SKIP** (◀◀ and ▶▶) button can be used during playing, but only within the range of the programmed tracks.
- The **SEARCH** (◀◀ and ▶▶) button can be used during playing to search all tracks, including unprogrammed tracks.
- The **PAUSE** mode can also be programmed (one time only), if so desired, by pressing the **TAPE** button instead of a numeric button. (In this case, "OO B" is illuminated on the display.)
- If, for a compact disc with 25 tracks or more, track number 25 or higher is programmed, the total time will disappear from the display.

### To stop program play

Press the **STOP** button. The first programmed track number will be displayed.

To resume play, press the **PLAY** button. Play will begin from the beginning of the program.

### To cancel a program sequence

There are several methods, as described below.

- Press the **STOP** button or the **CLEAR** button while the unit is stopped.
- Open the disc tray.
- Turn this unit into the standby mode.

### To check program data

1. If during program play, press the **STOP** button.
2. Press the **PROG** button.
3. Each time the **SKIP**  $\triangleright\triangleright$  button is pressed, the track numbers and sequential order of the programmed tracks can be checked one after another. The display of the track number can be returned (sequentially in reverse order) by pressing the **SKIP**  $\triangleleft\triangleleft$  button.

### To correct program data

1. Follow the procedure described in "To check program data".
2. Display the track number to be corrected by pressing the **SKIP** button.
3. Press a numeric button to select a track to replace the one displayed. The previously programmed track will be cleared from the memory and the new one will be programmed.
4. After the correction has been completed, once again press the **PROG** button or the **PLAY** button.

## INDEX SEARCH

If the disc includes index numbers, play can be started from any desired index number.

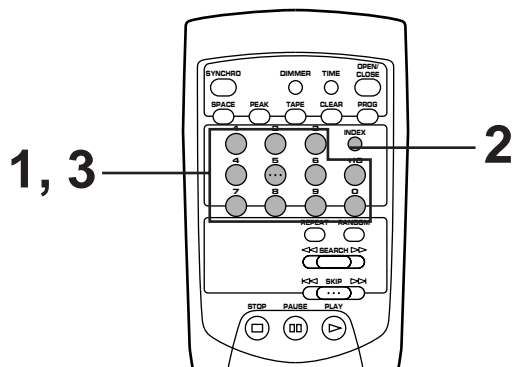

- 1** Select a track which has index numbers.

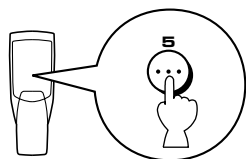

- 2** Press the **INDEX** button. The display shows the selected index number (5) and the word **INDEX**.

- 3** Select the desired index number.

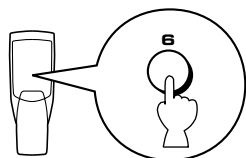

### To cancel the index search function

Press the **INDEX** button.

### Notes

- Not all discs have index numbers. The index system is a method for sub-dividing tracks into smaller divisions (such as, for example, the movements within classical symphonies) for easier location of those parts. The liner notes with the disc usually tell if such index numbers are included.
- If an index number is selected that is higher than any index number on that disc, play will start from the last index number point on the disc.
- For some discs, play may begin slightly prior to the actual designated index point.
- If the disc has no encoded index points, play will begin from the start of the selected track.
- The index number can be designated only while the **INDEX** number display is illuminated.

# TRACK PROGRAMMING FOR RECORDING TO TAPE

This convenient feature can be used to program tracks on a disc for recording to tape. By only memorizing the tape's total possible recording time, the unit will automatically program tracks or help you to program tracks so they will fit onto the tape with the least amount of unrecorded space remaining at each end of the tape.

## Automatic tape-programming

The unit will automatically program tracks on a disc with the original order of tracks unchanged.

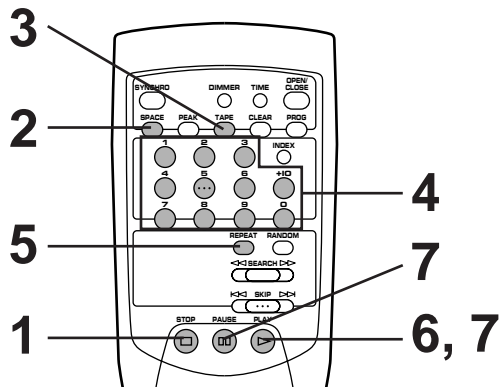

**1** Stop the unit.

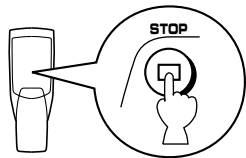

\* The peak level searching function of this unit is useful for adjusting recording level on the tape deck. (Refer to page 17.)

**2** If you desire, you can automatically insert additional time space between tracks. (Refer to page 9.)

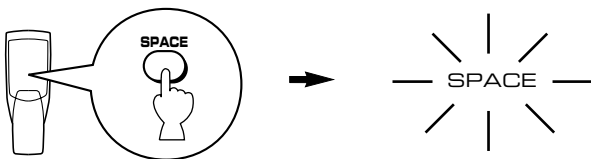

**3** Enter the tape's total possible recording time.

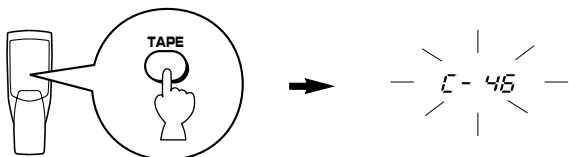

You can select any of four preset tape lengths by pressing the **TAPE** button.

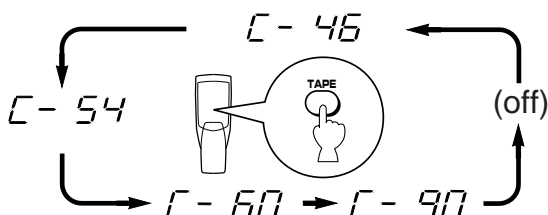

**4** If you desire, you can also enter the tape's total possible recording time manually after you select a preset tape length in step 3.

**Example:** For a C-64 tape (32 minutes on each side)

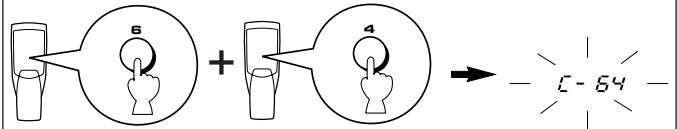

**5** Press the **REPEAT** button.

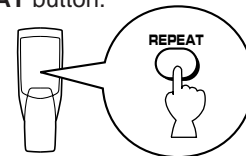

The unit automatically programs tracks for side A and side B separately considering the tape's total time.

\* The display shows momentarily the programmed track numbers, the total number of programmed tracks and the total time of programmed tracks for side A and B respectively.

**6** Begin recording on the tape deck and press the **PLAY** button on this unit at the same time.

**7** The unit will pause at the end of side A of the tape. Turn the tape over to side B. Resume recording and, at the same time, press the **PLAY** or **PAUSE** button on this unit.

### Notes

- All tracks may not be programmed if the tape's length is not enough. To program all tracks, use a longer tape.
- CD synchronized recording function can be used if your tape deck is compatible with it. If so, in step 6 and 7, press the **SYNCHRO** button and then press the **PLAY** button on this unit's remote control transmitter. Recording automatically begins. (For details, refer to page 18.)

### Display information (at step 5)

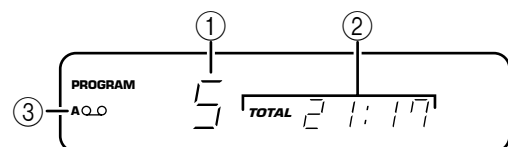

- ① Shows the number of programmed tracks for each side in turn just after the automatic programming is finished, and then it is replaced by the number of the first programmed track for side A.
- ② Shows the total time of programmed tracks for each side.
- ③ Shows the side of the tape.

### Note on tape programming

To check, cancel or correct program data, refer to page 13.

\* In checking the program data, note that "Pu" appears between track numbers for side A and side B.

## Manual tape-programming

This is for recording desired tracks in any desired order onto a tape.

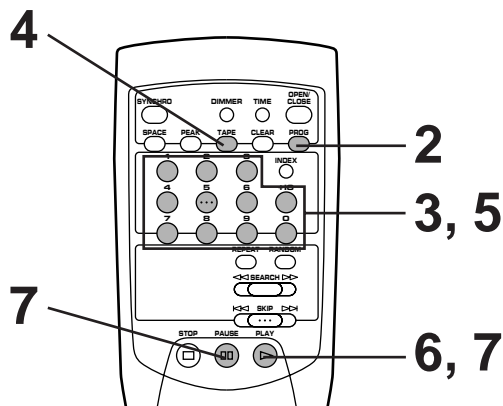

**1** Follow steps 1 – 4 on page 14.

**2**

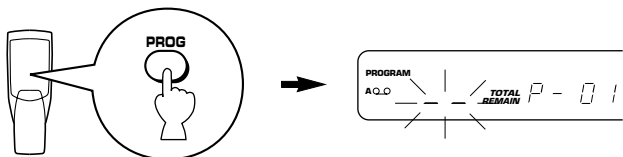

**3** Program desired tracks (to be recorded on side A) in any desired order.

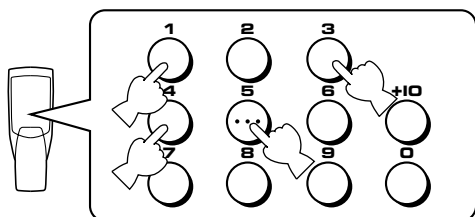

**4** When track selection for side A is finished, press the **TAPE** button.

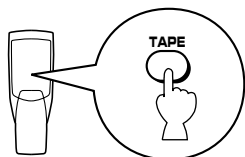

A pause mode is programmed.

**5** Select the track numbers (to be recorded on side B) in any desired order.

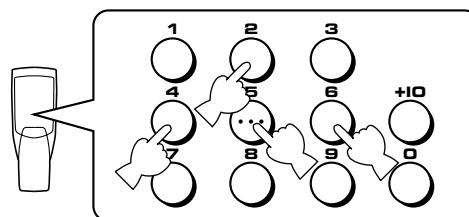

**6** Begin recording on the tape deck and press the **PLAY** button on this unit at the same time.

**7** The unit will pause at the end of side A of the tape. Turn the tape over to side B. Resume recording and, at the same time, press the **PLAY** or **PAUSE** button on this unit.

### Notes

- If, in step 3 or 5, "E rr" appears on the display, the track number just selected cannot be programmed because there is not enough time remaining on the tape.
- In step 3 or 5, each time a selection is made, the track number and the tape's remaining time will be displayed, and then the display will change to indicate the next program number.
- CD synchronized recording function can be used if your tape deck is compatible with it. If so, in step 6 and 7, press the **SYNCHRO** button and then press the **PLAY** button on this unit's remote control transmitter. Recording automatically begins. (For details, refer to page 18.)

### Notes on tape programming

- To check, cancel or correct program data, refer to page 13.
  - \* In checking the program data, note that "Pu" appears between track numbers for side A and side B.
- Up to a maximum of 25 tracks can be programmed. If, however, the PAUSE mode is inserted, it is counted as one track.

- This function can be used to program up to track number 24. If the disc has more than 24 tracks, track number 25 and thereafter will not be programmed.

## ■ Random sequential tape-programming

The unit will automatically program tracks in random sequential order for recording to tape.

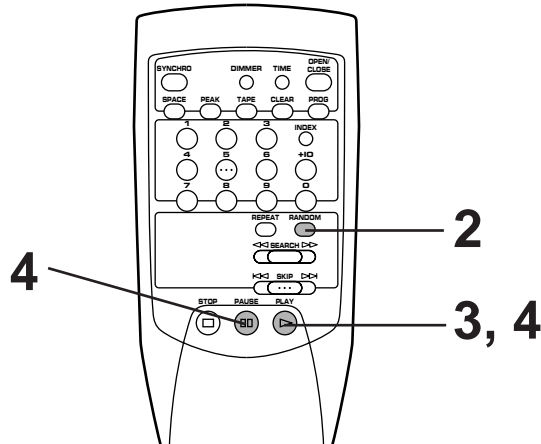

**1** Follow steps 1 – 4 on page 14.

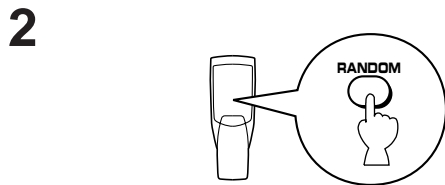

The unit will automatically program tracks for side A and side B separately considering the tape's total time.

\* The display shows momentarily the programmed track numbers, the total number of programmed tracks and the total time of programmed tracks for side A and B respectively.

**3** Begin recording on the tape deck and press the **PLAY** button on this unit at the same time.

**4** The unit will pause at the end of side A of the tape. Turn the tape over to side B. Resume recording and, at the same time, press the **PLAY** or **PAUSE** button on this unit.

### Notes

- Because the programmed data changes every time the **RANDOM** button is pressed, the amount of time remaining at the end of the tape also changes accordingly.
- If the tape's length is not enough, all tracks cannot be programmed. In this case, exchange the tape for a longer one.
- CD synchronized recording function can be used if your tape deck is compatible with it. If so, in step 3 and 4, press the **SYNCHRO** button and then press the **PLAY** button on this unit's remote control transmitter. Recording automatically begins. (For details, refer to page 18.)

### Display information (at step 2)

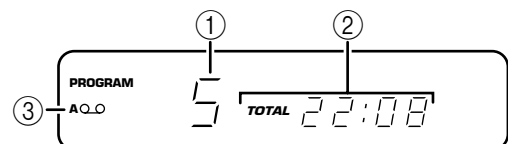

- ① Shows the number of programmed tracks for each side in turn just after the automatic programming is finished, and then it is replaced by the number of the first programmed track for side A.
- ② Shows the total time of programmed tracks for each side.
- ③ Shows the side of the tape.

### Note on tape programming

To check, cancel or correct program data, refer to page 13.

\* In checking the program data, note that "Pu" appears between track numbers for side A and side B.



## Automatic searching for the peak level on a disc

This convenient feature automatically searches a disc for a part where the source level peaks, and next plays the part repeatedly. For recording to tape, this feature is very helpful to adjust the recording level on the tape deck.

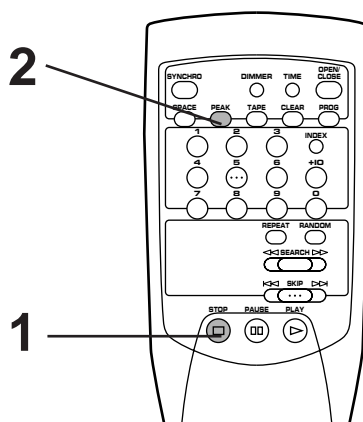

### 1 Stop the unit.

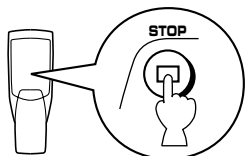

### 2

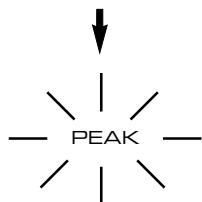
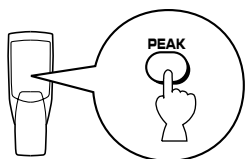

The peak level search is performed on the disc.

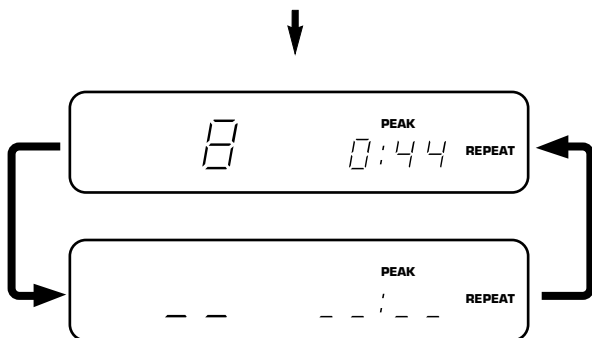

Next, the part where the source level peaks is repeatedly played. Adjust the recording level on the tape deck listening to this sound.

### To cancel this function

Press the **STOP** button. (Some other buttons can also be used to cancel this function.)

### Notes

- Even if the peak level search is performed twice or more on the same disc, the same part will not be always selected, because this unit will search for the peak level among parts on the disc that are randomly selected by the internal microcomputer.
- In the program play mode, this feature will function among the programmed tracks only. If program play is being performed, first press the **STOP** button, and then press the **PEAK** button. If program play is not being performed, only press the **PEAK** button.

# CD SYNCHRONIZED RECORDING

This unit can make a tape deck's recording synchronized with CD play automatically. With this function, you can record a CD on tape very easily and more precisely. This recording method needs a YAMAHA tape deck compatible with this function. (Refer to the tape deck's operation manual to know whether it is compatible or not.)

\* This unit and the tape deck must be placed close to each other so that both of them can receive the signals from this unit's remote control transmitter at the same time.

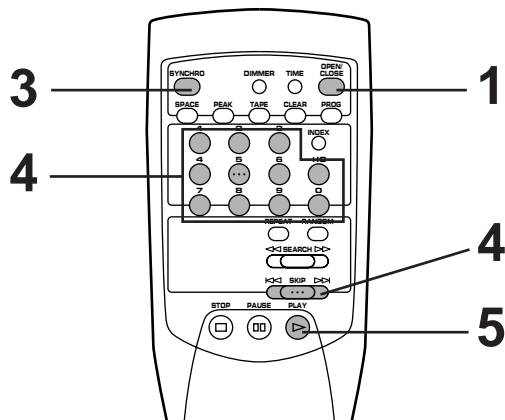

**1** Load the disc.

**2** Load a tape on the tape deck.  
\* The peak level search function of this unit is useful for adjusting recording level on the tape deck. (Refer to page 17.)

**3**

This unit enters into the pause mode, and the tape deck enters into the REC/PAUSE mode.  
\* In this mode, the time display on this unit flashes on and off.

**4** If necessary, select a desired track.

**5**

Both CD play and tape deck recording begin.  
\* CD play begins a little later than recording.

**6** If you want to stop recording temporarily and restart recording from a desired track, follow steps 3–5 again.

## To cancel this function

Press the **STOP** button.

## Notes

- To finish or stop the recording, make proper operations on the tape deck.
- Programmed sequence of tracks can also be recorded with this function, instead of recording an entire disc. (Refer to page 12–13 for the programming procedure.)
- This function can also be used together with the automatic tape-programming function. (Refer to page 14–16.)

# NOTES ABOUT THE REMOTE CONTROL TRANSMITTER

## Battery installation

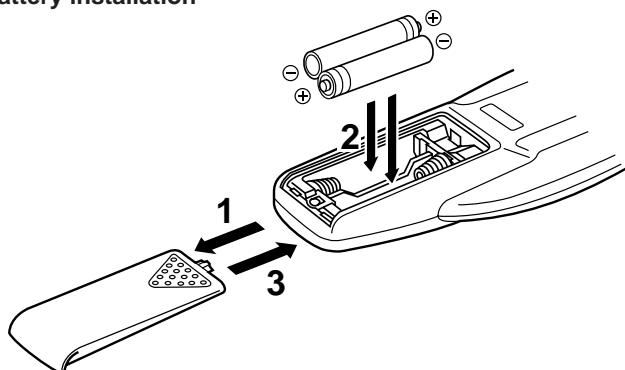

## Battery replacement

If you find that the remote control transmitter must be used closer to the main unit, the batteries are weak. Replace both batteries with new ones.

### Notes

- Use only AA, R6, UM-3 batteries for replacement.
- Be sure the polarities are correct. (See the illustration inside the battery compartment.)
- Remove the batteries if the remote control transmitter will not be used for an extended period of time.
- If batteries leak, dispose of them immediately. Avoid touching the leaked material or letting it come in contact with clothing, etc. Clean the battery compartment thoroughly before installing new batteries.

## Remote control transmitter operation range

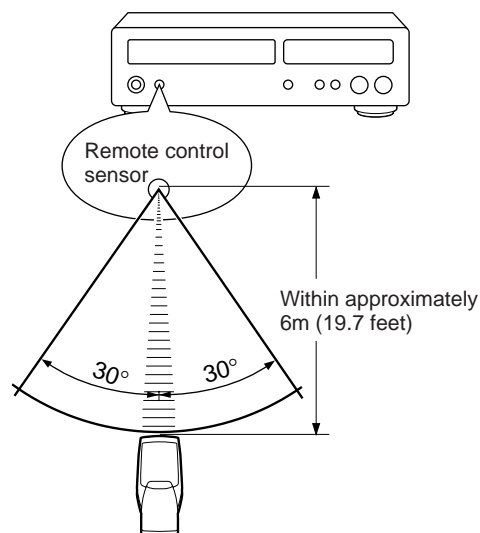

### Notes

- There should be no large obstacles between the remote control transmitter and the main unit.
- If the remote control sensor is directly illuminated by strong lighting (especially an inverter type of fluorescent lamp etc.), it might cause the remote control transmitter not to work correctly. In this case, reposition the main unit to avoid direct lighting.

# NOTES ABOUT HANDLING COMPACT DISCS

- This compact disc player is designed only for playing compact discs bearing the  mark. Never attempt to load any other type of disc into the unit. The unit will also play 8-cm (3-inch) compact discs.
- To remove a disc from its storage case, open the case and then press down at the center; with a finger through the center hole and the outer edges held as shown in the illustration, lift the disc out carefully.

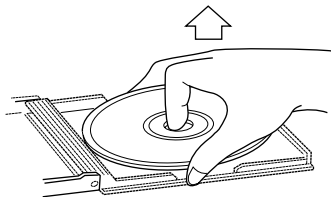

- Always handle the disc with care so that its surface is not scratched.

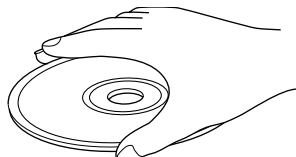

- Compact discs are not subjected to wear during play, but damage to the disc surface when the disc is being handled can adversely affect the disc's play.

- Compact discs are not affected by small particles of dust or fingerprints on their playing surface, but even so they should be kept clean. Wipe by using a clean, dry cloth. Do not wipe with a circular motion; wipe straight outward from the center.

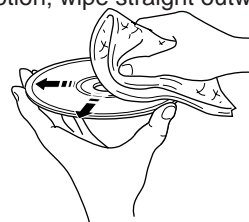

- Do not try to clean the disc's surface by using any type of disc cleaner, record spray, anti-static spray or liquid, or any other chemical-based liquid, because such substances might irreparably damage the disc's surface.
- Do not expose discs to direct sunlight, high temperature or high humidity for a long period of time, because these might warp or otherwise damage the disc.

**No!**



### To play a 8-cm (3-inch) CD

Place it in the inner recessed area of the disc tray. Do not put a normal (12-cm/5-inch) CD on top of a 8-cm CD.

# TROUBLESHOOTING

If the unit fails to operate normally, check the following points to determine whether the fault can be corrected by the simple measures suggested. If it cannot be corrected, or if the fault is not listed in the SYMPTOM column, disconnect the power cord and contact your authorized YAMAHA dealer or service center for help.

SYMPTOM	PROBABLE CAUSE	REMEDY
The player does not switch ON when the STANDBY/ON switch is pressed.	The power cord is not connected or not completely connected.	Securely connect the power cord.
It happens that this unit does not work normally.	There is an influence of strong external noise (lightning, excessive static electricity, etc.) or a misoperation on this unit while using this unit.	Turn this unit into the standby mode and disconnect the AC power cord from the AC outlet. After about 30 seconds have passed, connect the power and operate this unit again.
The disc tray does not close completely.	A foreign object is obstructing the tray.	Carefully check the disc tray and remove the foreign object.
Play does not begin.	The disc is damaged.	Check the disc carefully; replace it if necessary.
	There is moisture on the laser pickup.	Wait 20 to 30 minutes after switching the unit ON before trying to play a disc.
	The disc has been loaded upside down.	Reload the disc with the label side up.
	The disc is dirty.	Clean the disc.
Play is delayed, or begins at the wrong place.	The disc may be scratched or damaged.	Check the disc carefully; replace it if necessary.
No sound.	Improper output cable connections.	Connect the cables properly. If the problem persists, the cables may be defective.
	Improper amplifier operation.	Set the amplifier controls to the correct input selection.
Sound "skips".	The player is being subjected to vibrations or impacts.	Relocate the player.
	The disc is dirty.	Clean the disc.
Sound "hums".	Improper cable connections.	Securely connect the audio cables. If the problem persists, the cables may be defective.
Noise from a nearby tuner.	The tuner is too close to the player.	Move the tuner and player farther apart.
Noise from inside of the disc tray.	The disc may be warped.	Replace the disc.
The remote control transmitter does not work.	The batteries of this remote control transmitter are too weak.	Replace the batteries with new ones.
	Direct sunlight or lighting (of an inverter type of fluorescent lamp etc.) is striking the remote control sensor of the main unit.	Change position of the main unit.

# SPECIFICATIONS

## AUDIO SECTION

Frequency response .....	2 Hz – 20 kHz, ±0.3 dB
Harmonic distortion + noise (1 kHz) .....	0.0022%
S/N ratio .....	118 dB
Dynamic range .....	98 dB
Wow & flutter .....	Unmeasurable
Output voltage .....	2.0 ± 0.5V

## GENERAL

<b>Power requirements</b>	
U.S.A. model .....	120V, 60 Hz
Europe and U.K. models .....	230V, 50 Hz
General model .....	110/120/220/240V, 50/60 Hz
<b>Power consumption</b> .....	15W
<b>Dimensions (W x H x D)</b> .....	280 x 82.5 x 354 mm (11" x 3-1/4" x 13-15/16")
<b>Weight</b> .....	3.8 kg (8 lbs. 6 oz.)
<b>Accessories</b> .....	Connection cord Remote control transmitter Batteries (size AA, R6, UM-3)

Please note that all specifications are subject to change without notice.

# STORINGZOEKEN

Controleer de volgende punten, indien het apparaat niet normaal functioneert en bepaal of het probleem verholpen kan worden door de eenvoudige hieronder gesuggereerde maatregelen te nemen. Kan het probleem niet worden verholpen, of staat het probleem niet vermeld in de STORINGSINDICATIE kolom, het netsnoer van het apparaat uit het stopcontact verwijderen en voor verdere hulp contact opnemen met uw dealer of een reparatiedienst.

STORINGSINDICATIE	MOGELIJKE OORZAAK	OPLOSSING
De speler wordt niet ingeschakeld wanneer de STANDBY/ON schakelaar wordt ingedrukt.	Het netsnoer is niet aangesloten of niet volledig aangesloten.	Sluit het netsnoer goed aan.
Het doet zich voor dat dit apparaat niet normaal functioneert.	Er is een invloed van een krachtige storing van buitenaf (bliksem, buitengewoon veel statische elektriciteit, enz.) of een verkeerde bediening van dit apparaat.	Schakel dit apparaat in de standby functie en verwijder de stekker van het netsnoer uit het stopcontact. Na ongeveer 30 seconden de stekker weer in het stopcontact steken, dit apparaat weer inschakelen en opnieuw proberen te bedienen.
De disc-lade sluit niet volledig.	De disc-lade wordt door een vreemd voorwerp gehinderd.	Controleer voorzichtig de disc-lade en verwijder het vreemde voorwerp.
De weergave begint niet.	De disc is beschadigd.	Controleer de disc nauwkeurig; vernieuw deze indien nodig.
	Er bevindt zich vocht op de laser pick-up.	Wacht 20 tot 30 minuten na het inschakelen van het apparaat, alvorens te proberen een disc af te spelen.
	De disc is ondersteboven in de lade geplaatst.	Laad de disc opnieuw met het label naar boven gericht.
	De disc is verontreinigd.	Reinig de disc.
De weergave begint vertraagd of begint op het verkeerde punt.	De disc is vermoedelijk bekrast of beschadigd.	Controleer de disc nauwkeurig; vernieuw deze indien nodig.
Geen geluid.	Verkeerde aansluiting van de uitgangssignaalkabels.	Sluit de kabels op de juiste wijze aan. Indien het probleem blijft voortbestaan, zijn de kabels vermoedelijk defect.
	Verkeerde bediening van de versterker.	Stel de regelaars van de versterker in op de juiste ingangssignaalkaakze.
Het geluid "springt over".	De speler is onderhevig aan trillingen of schokken.	Stel de speler op een andere plaats op.
	De disc is verontreinigd.	Reinig de disc.
Het geluid "bromt".	Verkeerde aansluiting van de kabels.	Maak de audiokabels goed vast. Indien het probleem blijft voortbestaan, zijn de kabels vermoedelijk defect.
Storing van een in de buurt opgestelde tuner.	De tuner bevindt zich te dicht bij de speler.	Plaats de tuner en de speler verder uit elkaar.
Storing van binnenuit de disc-lade.	De disc is vermoedelijk kromgetrokken.	Vernieuw de disc.
De zender van de afstandbediening werkt niet.	De batterijen van deze afstandbediening zijn te zwak.	Vervang de batterijen door nieuwe.
	Direct zonlicht of verlichting (van een sterke fluorescerende lamp, enz.) valt op de sensor van de afstandbediening van de hoofdeenheid.	Verander de opstelling van de hoofdeenheid.

# SPECIFICATIES

## AUDIO GEDEELTE

Frekwentiebereik .....	2 Hz – 20 kHz, $\pm 0,3$ dB
Harmonische vervorming + ruis (1 kHz) .....	0,0022%
Signaal/ruisverhouding .....	118 dB
Dynamisch bereik .....	98 dB
Wow & flutter .....	Onmeetbaar
Uitgangsspanning .....	2,0 $\pm$ 0,5V

## ALGEMEEN

Spanningsvereisten	
Modellen voor U.S.A. ....	120V, 60 Hz
Modellen voor Europa en Groot-Brittannië	
.....	230V, 50 Hz
Algemeen model .....	110/120/220/240V, 50/60 Hz
Stroomverbruik.....	15W
Afmetingen (L x H x B) .....	280 x 82,5 x 354 mm
Gewicht .....	3,8 kg
Toebehoren .....	Aansluitkabel, afstandbediening, batterijen (format AA, R6, UM-3)

Alle specificaties zijn onder voorbehoud en kunnen zondere nadere kennisgeving worden gewijzigd.